

D-POWER 1

A



CLIP



I-OUT



SIGNAL



ON



B



CLIP



I-OUT



SIGNAL



ON



MB

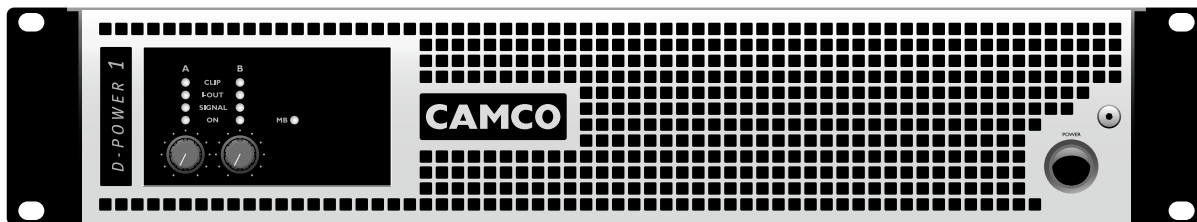

INFORMATION FOR USE FOR *D-POWER 05 & D-POWER 1*

D1UM_GB_2012-R1_02-2012

The leading version of this brochure is the English one which shall prevail to the exclusion of the national translation on hand.

Copyright 2012 by **CAMCO** Produktions- und Vertriebs-GmbH
für Beschallungs- und Beleuchtungsanlagen
Fischpicke 5, D-57482 Wenden, Germany
Telephone +49 (0) 2762 408-0

D - POWER SERIES

Please visit our website www.camcoaudio.com for the latest version of this user manual. Please note that the leading version of CAMCO manuals is always the English one.

IMPORTANT SAFETY INSTRUCTIONS

1. General

The amplifier may only be used in accordance with the information provided in the user manual. Before and during the usage of the amplifier please ensure that all recommendations, especially the safety recommendations as detailed in the user manual, are adhered to.

The **D-POWER 05/1** amplifier is designed for the amplification of pulsed audio signals. The amplifier should only be connected to speakers with an average impedance as indicated.

2. User Manual

Read the information for use (user manual) and heed all warnings. Keep this user manual in a safe place during the lifetime of the amplifier. The user manual forms an integral part of the amplifier. Reselling the amplifier is only possible if the user manual is available. In case of reselling the amplifier, the reseller has to document any changes made to the amplifier in writing and pass the documentation on to the buyer.

3. Environments

Use this amplifier only in E1, E2, E3, or E4 environments according to EN55103-2 "Electromagnetic compatibility – Product family standard for audio, video, and audio-visual and entertainment lighting control apparatus for professional use – Part 2: Immunity".

4. Mounting/Placement

Do not place this amplifier on an unstable cart, stand, tripod, bracket, or table. The amplifier may fall causing serious injury and serious damage to the product. Any mounting of the amplifier should follow the manufacturer's instructions. Only mounting accessory shall be used which is recommended by the manufacturer.



5. Power Cord Protection

Power supply cords should be routed so that they are not likely to be walked on or pinched by items placed upon them or against them, paying particular attention to cords and plugs and the point where they exit from the amplifier.

6. Heat

Do not use this amplifier near any heat sources such as radiators, heat registers, stoves, or other apparatuses that produce heat.

7. Water and Moisture

Do not expose this device to rain or moisture. Do not use this amplifier near water (for example swimming pools and fountains). Do not place any objects containing liquids, such as bottles or glasses, on the top of the unit. Do not splash liquids on the unit. IP-20 equipment. There is no protection against splashing water.

8. Ventilation

Slots and openings in the cabinet are provided for ventilation to ensure reliable operation of the amplifier and to protect it from overheating. These openings must not be blocked or covered. This amplifier should not be installed unless proper ventilation is provided or manufacturer's instructions have been adhered to.

9. Interference Of External Objects and/or Liquids with the Appliance

Never push objects of any kind into this amplifier through openings as they may touch dangerous voltage points or short-out parts that could result in fire or electric shock. Never spill liquid of any kind on the amplifier.

10. Connections

When you connect the amplifier to other equipment, turn off the power and unplug all of the equipment from the supply source. Failure to do so may cause an electric shock and serious personal injury. Read the user manual of the other equipment carefully and follow the instructions when making the connections.

11. Lightning

For additional protection of this amplifier during lightning storms or when it is left unattended and/or unused for long periods of time, unplug it from the wall outlet. This will prevent damage to the amplifier due to lightning and power line surges. Disconnection from the mains power supply can only be achieved by removing the plug from the mains socket and by external disconnecting all poles from the mains.

12. Damages that Require Service

Unplug this amplifier from the mains supply and refer to your dealer/distributor or other authorized repair workshop if any of the following situations occur:

- if liquid has been spilled or objects have fallen into the amplifier
- if the amplifier has been exposed to rain or moisture
- if the amplifier has been dropped or damaged in any other way
- if the power supply cord or plug has been damaged
- when the amplifier exhibits a distinct change from its normal function or performance
- in case the amplifier has been used in a dusty environment for quite a period of time

13. Servicing

All service and repair work must be carried out by a dealer/distributor authorized by **CAMCO**. Do not attempt to service this amplifier yourself. As opening or removing covers may expose you to dangerous voltage or other hazards, the amplifier may only be opened by qualified personnel. Please refer to your dealer/distributor.

14. Spare Parts

When spare parts are required, please ensure that the dealer/distributor only uses spare parts specified by the manufacturer. The use of unauthorized spare parts may result in injury and/or damage through fire or electric shock or other electricity-related hazards.

15. Safety Check

Upon completion of any service or repairs to this product, ask the dealer/distributor to perform safety checks to determine that the amplifier works properly.

Recommendations on how to carry out the safety test can be found in DIN VDE 0701-1 "Maintenance, Modification and Test of Electronic Appliances".

16. Cleaning

Unplug this amplifier from the wall outlet before cleaning. Do not use liquid or aerosol cleaners. Clean only with dry cloth.

17. Packaging and Shipping

When shipping the **D-POWER 05/1** amplifier, always use the original shipping carton and packing materials. For maximum protection repack the unit as it was originally packed at the factory.



CAUTION
RISK OF ELECTRIC SHOCK
DO NOT OPEN



CAUTION – HIGH VOLTAGE HAZARDS
EXIST WITHIN THIS PRODUCT.
REFER ALL SERVICING TO
AUTHORIZED PERSONNEL.



THE LIGHTNING FLASH WITH ARROW HEAD SYMBOL IS INTENDED TO
ALERT THE USER TO THE PRESENCE OF UNINSULATED DANGEROUS
VOLTAGE WITHIN THE PRODUCT'S ENCLOSURE.



THE EXCLAMATION MARK IS INTENDED TO ALERT THE USER
TO IMPORTANT INSTRUCTIONS ALSO FOR MAINTENANCE IN THE
LITERATURE ACCOMPANYING THE AMPLIFIER.



THE LIGHTNING FLASH WITH ARROW HEAD SYMBOL ALERTS
THE USER TO DANGEROUSLY HIGH VOLTAGE AT THE OUTPUT
CONNECTORS! THAT COULD POTENTIALLY BE LIFE THREATENING.

CAUTION – RISK OF ELECTRIC SHOCK – DO NOT OPEN.

WARNING – TO PREVENT FIRE OR SHOCK HAZARD, DO NOT
EXPOSE THIS AMPLIFIER TO RAIN OR MOISTURE.



THE AMPLIFIER MAY ONLY BE CONNECTED
TO A SOCKET WITH A PROTECTIVE EARTH CONDUCTOR.

EC Declaration Of Conformity In Accordance To EC Directives:
electromagnetic compatibility (Council Directive 2004/108/EC);
low-voltage electrical equipment (Council Directive 2006/95/EC)

Manufacturer's Name:

CAMCO Produktions- und Vertriebs-GmbH
für Beschallungs- und Beleuchtungsanlagen

Manufacturer's Address:

Fischpicke 5, D-57482 Wenden, Germany

Declares That The Product With The Model Name:

CAMCO Power amplifier *D-POWER 05* and *D-POWER 1*

Conforms To The Following Standards:

- EN60065 Safety
- EN55103-1 Emission
- EN55103-2 Immunity

The operating conditions and application environments presupposed in the information for use (user manual) are to be kept to accordingly.

Wenden, 30.09.2011



Joachim Stöcker

P.2	IMPORTANT SAFETY INSTRUCTIONS	
P.4	EXPLANATION OF SYMBOLS	
P.5	EC DECLARATION OF CONFORMITY	
P.6	CONTENTS	
P.7	1 WELCOME	
	1.1 Welcome To CAMCO	
	2 THE AMP	
	2.1 Unpacking	
P.8	2.2 The Amplifier	
P.9	2.3 D-POWER – The Front	
	2.4 D-POWER – The Rear	
P.10	2.5 Factory settings	
P.11	3 INSTALLATION	
	3.1 Mounting	
	3.2 Cooling	
P.12	3.3 Mains	
	3.3.1 Mains Supply	
P.13	3.3.2 On/Off Switch	
	3.4 Wiring	
	3.4.1 Input Connections	
P.14	3.4.2 SPEAKON® Connection	
P.15	4 OPERATION	
	4.1 Controls	
	4.1.1 Volume Control	
	4.1.2 Mode Selector	
	4.1.3 Dual Channel Operation (Stereo)	
P.16	4.1.4 Mono Bridge Operation	
	4.2 Indicators	
	4.2.1 On LEDs	
	4.2.2 Signal/Protect LEDs (multifunctional)	
P.17	4.2.3 Output Current LEDs	
	4.2.4 Clip LEDs (multifunctional)	
	4.2.5 Mono Bridge Mode Indicator	
P.18	4.3 Power Amp Protection Systems	
	4.3.1 Clip Limiter	
	4.3.2 DC Protection	
	4.3.3 Over Current Protection	
	4.3.4 Thermal Protection	
P.18	4.4 Main Protections	
	4.4.1 Inrush Current Limitation	
	4.4.2 Mains Over Voltage Detection	
	4.5 Main SMPS Protections	
	4.5.1 Over Current Protection	
	4.6 Fans	
P.19	4.7 Filter Cleaning	
P.20	5 TROUBLESHOOTING	
	5.1 Problem: No Sound	
	5.2 Problem: No Channel Separation	
	5.5 Problem: Distorted Sound	
	5.6 Problem: Hiss	
	5.7 Problem: Squeals and Feedback	
P.21	6 SPECIFICATION	
P.23	7 TYPICAL PERFORMANCE DIAGRAMS	
P.26	8 WARRANTY INFORMATION	
	8.1 Summary of Warranty	
	8.2 Items Excluded from This Warranty	
	8.3 What CAMCO Will Do	
	8.4 How to Obtain Warranty Service	
	8.5 CAMCO's Product Improvement	
P.27	9 SERVICE INFORMATION	
P.28	10 MAINTENANCE INFORMATION	
	11 DECOMMISSIONING	
P.29	COMPANY INFORMATION	
P.30	CHANGES MADE TO THE AMPLIFIER / NOTICES	

1.1 Welcome to CAMCO

Established in 1983, **CAMCO** has gained worldwide experience with professional sound reinforcement technology. Within the audio market **CAMCO** specialises in the production and marketing of high quality power amplifiers and sound systems for use both on tour and in fixed installations.

The success of the **VORTEX**, **TECTON** and **Q-POWER** series of power amps has made the **CAMCO** name synonymous with professional quality, high performance and utterly reliable power amps.

CAMCO's commitment to research and development, seen not just in the area of materials and technology but also most importantly in its highly skilled and motivated workforce, is one of the keys to its ongoing success.

Welcome to the new world of professional power amplifiers –

WELCOME TO CAMCO!

2.1 Unpacking

Please unpack and inspect your new amplifier for any damage that may have occurred during transit. If damage is found, notify the transportation company immediately. Only you the consignee may initiate a claim for shipping damage. **CAMCO** will be happy to cooperate fully as needed. Please save the shipping carton as evidence of damage for the shipper's inspection.

Even if the amplifier has arrived in perfect condition, save all packing materials so you will have them if you ever need to transport the unit.

NEVER SHIP THE AMPLIFIER WITHOUT THE ORIGINAL PACKING MATERIALS.

When shipping the **D-POWER** amplifier, always use the original shipping carton and packing materials. For maximum protection, repack the unit as it was originally packed at the factory.

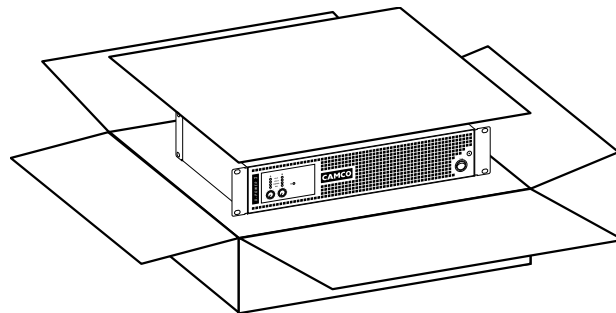

2.2 The Amplifier

The **D-POWER** is a Class-D power amplifier with a power output of:

D-POWER 05 250 W per channel @ 4 Ω
 125 W per channel @ 8 Ω
 500 W in Mono Bridge @ 8 Ω

D-POWER 1 500 W per channel @ 4 Ω
 250 W per channel @ 8 Ω
 1000 W in Mono Bridge @ 8 Ω

D-POWER amplifiers are fitted with Switched Mode Power Supplies (SMPS), which significantly reduces the weight and size (only 2U) of the amplifier. Using SMPS, the 2 symmetrical supply voltages of the power amplifier are more stable than the power supplies used in conventional amplifiers.

The **D-POWER** has been designed as an intelligent and powerful product for performing specialised tasks within a complex audio system. Users can adapt the power amp to meet their specific audio requirements before use. Controls mounted on the front and the rear of the **D-POWER** allow access to the functionality.

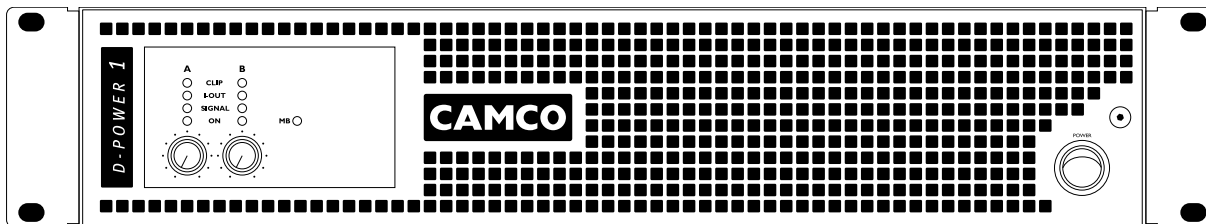

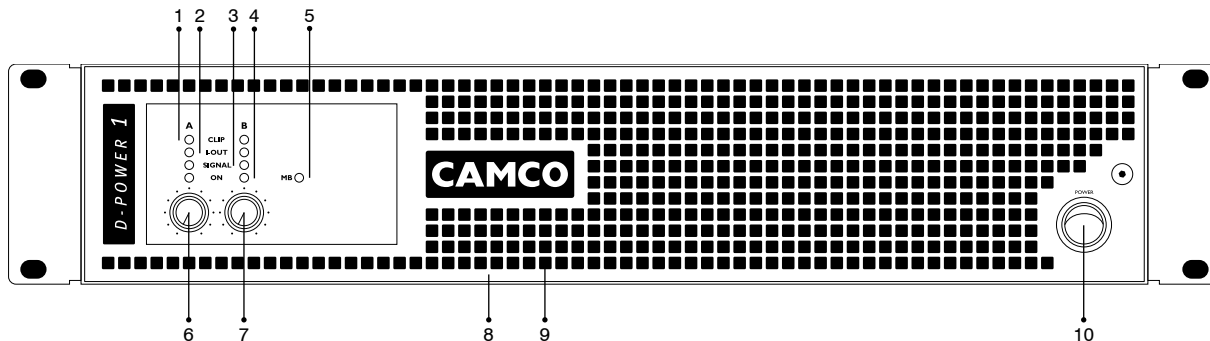

2.3 D-POWER - The Front

- | | |
|------------------------|-------------------------------|
| 1 Clip LEDs | 6 Volume Control Channel A |
| 2 Output Current LEDs | 7 Volume Control Channel B |
| 3 Signal LEDs | 8 Removable Air Filter System |
| 4 On LEDs | 9 Cooling Air Inlet Vents |
| 5 Mono Bridge Mode LED | 10 On/Off Switch |

2.4 D-POWER - The Rear

- | | |
|-----------------------------|-------------------------|
| 11 AC Line Connector | 15 XLR/Jack Line Inputs |
| 12 Cooling Air Outlet Vents | 16 Jack Line Inputs |
| 13 SPEAKON® Connectors | 17 Rating Plate |
| 14 Mode Selector | |

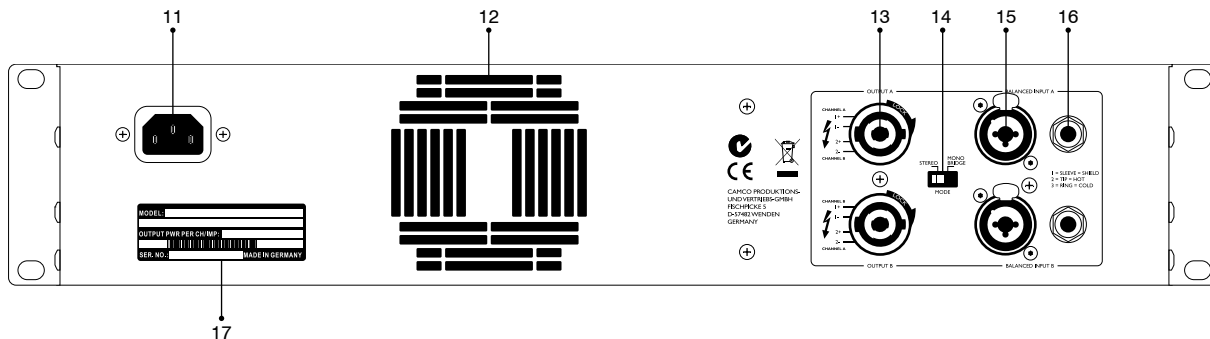

2.5 Factory Settings

D-POWER amplifiers are delivered with the following factory settings

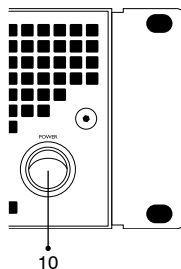
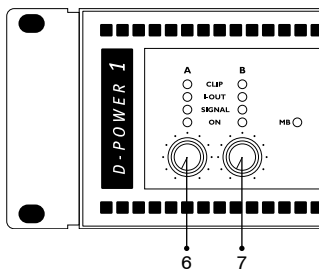

Front panel:

- | | | |
|----|--------------------------|--------------------------------|
| 6 | Volume Control Channel A | The volume is set to minimum. |
| 7 | Volume Control Channel B | The volume is set to minimum. |
| 10 | On/Off Switch | The amplifier is switched off. |

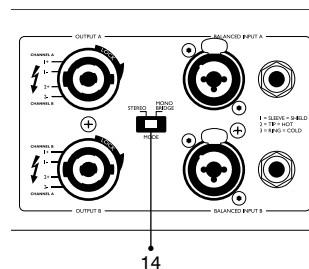

Rear panel:

- | | | |
|----|---------------|---------------------|
| 14 | Mode Selector | Stereo/Dual Channel |
|----|---------------|---------------------|

3.1 Mounting

Use four screws and washers when mounting the amplifier to the front rack rails.

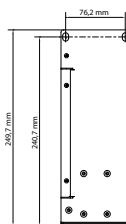
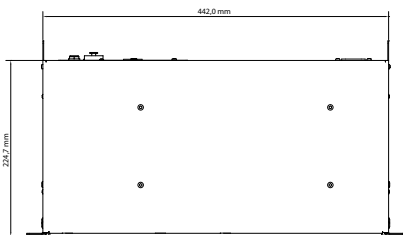
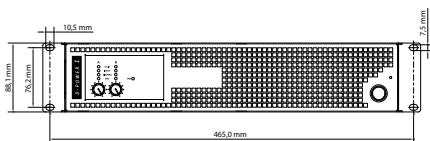

3.2 Cooling

Under normal operation of the power amp, overheating should never be a problem. The amplifier uses passive cooling through its internal heatsinks. Only when the temperature rises above approx. 60°C, the fan is switched on. When the fan is running, the air is taken in from the front and out through the back. It is essential that while the amplifier is running the air is able to circulate around it freely.

The efficiency of the cooling will depend on the immediate environment (e.g. an enclosed rack, direct sunlight). If the amp is installed in a case, the open area at the back of the case must be at least 140 cm². This area should be in line with the amplifier.

If this cannot be achieved a forced ventilation system has to be used.

3.3 Mains

3.3.1 Mains Supply

When mounting or connecting the amp always disconnect it from mains. Only connect the **D-POWER** amplifier to an appropriate AC circuit and outlet, according to the requirements indicated in the second line on the rating plate.

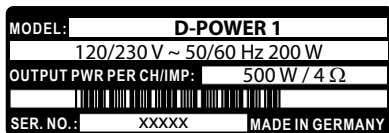
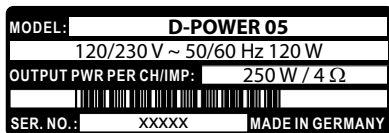

Rating plates for **D-POWER 05** and **D-POWER 1**.

Mains current draw and power consumption at different mains voltages with 1/8th of rated output power into 4 Ω load, both channels driven:

Measured with pink noise with crest factor of 12 dB to represent typical music signal.

	Voltage	Mains Frequency	Current	Power Consumption
D-POWER 05	100 V	50/60 Hz	1,80 A	120 W
D-POWER 05	120 V	50/60 Hz	1,55 A	120 W
D-POWER 05	200 V	50/60 Hz	1,15 A	120 W
D-POWER 05	230 V	50/60 Hz	1,00 A	120 W
D-POWER 1	100 V	50/60 Hz	2,90 A	200 W
D-POWER 1	120 V	50/60 Hz	2,60 A	200 W
D-POWER 1	200 V	50/60 Hz	1,75 A	200 W
D-POWER 1	230 V	50/60 Hz	1,60 A	200 W

Mains current draw and power consumption @ 230 V, 50 Hz at different output power levels with 4 Ω load, both channels driven:

Measured with pink noise with crest factor of 12 dB to represent typical music signal.

Operating condition	Mains current	Power consumption	Output power
Idle (amplifier powered on)	0,3 A	23 W	0 W
32 W per channel	1 A	120 W	64 W
63 W per channel	1,6 A	200 W	126 W
125 W per channel*	2,7 A	350 W	250 W
200 W per channel*	3,9 A	530 W	400 W

*: duration limited by thermal limitation

3.3.2 On/Off Switch

The On/Off Switch is a rocker-type switch. It is located on the right side of the front panel. To turn the amplifier on, press on the upper part of the switch. During power up the Clip and Signal LEDs from both channels will light up in red for a few seconds. To turn the amplifier off, press on the lower part of the switch.

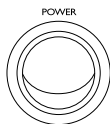

Amplifier is switched on

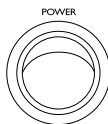

Amplifier is switched off

The switch initiates a short power supply start-up sequence. After a few seconds the amplifier is operational.

Disconnect the mains plug from the mains during a lightning storm or when the amplifier remains unused or unsupervised for a prolonged period of time. Alternatively, you can disconnect the amplifier via an external all-pole disconnection from the mains.

If a power cut occurs while the amplifier is switched on, it will restart automatically once the power supply has been restored.



**DO NOT REMOVE MAINS CONNECTOR GROUND
IT IS ILLEGAL AND DANGEROUS**

3.4 Wiring

3.4.1 Input Connections

XLR: Pin 1 = Ground
Pin 2 = Hot (inphase)
Pin 3 = Cold (out of phase)

Jack: Tip = Hot (inphase)
Ring = Cold (out of phase)
Sleeve = Ground

Always use symmetrical (balanced) shielded cable to connect the **D-POWER** amplifier.

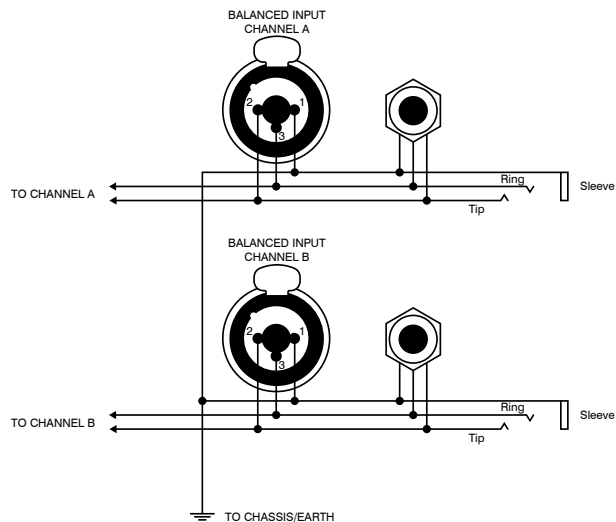

3.4.2 SPEAKON® Connection

Both SPEAKON® connectors are connected to channel A and channel B outputs. The pin configuration of the SPEAKON® connectors is as follows:

Upper SPEAKON®:

Pin 1+	Channel A signal
Pin 1-	Channel A ground
Pin 2+	Channel B ground
Pin 2-	Channel B signal

Lower SPEAKON®:

Pin 1+	Channel B ground
Pin 1-	Channel B signal
Pin 2+	Channel A signal
Pin 2-	Channel A ground

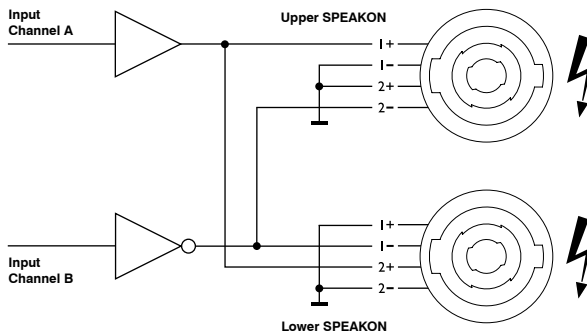

ATTENTION!

Channel B's output polarity is inverted. This means that the active (hot) amplifier output is connected to the negative SPEAKON® contact. Connecting this contact to ground or earth inside loudspeakers, cabling or other equipment would short-circuit the amplifier output stage!

WARNING !

SPEAKON® connectors marked with the lightning flash indicate high voltages that are potentially life threatening.

Wiring to these terminals requires installation by an instructed person or the use of ready-made leads or cords.

Custom wiring should only be made by qualified personnel.

To prevent electric shock, do not operate the amplifier with any of the conductor portion of the speaker wire exposed.

NOTE:

For reasons of safety and performance, use only high-quality fully insulated speaker cables of stranded copper wire. Use the largest wire size that is economically and physically practical, and make sure the cables are no longer than necessary.

4.1 Controls

4.1.1 Volume Control

A volume control with 41 notched settings controls the audio signal. These settings have been selected to correspond to human hearing characteristics (logarithmically) and therefore guarantee an optimal range of settings for practical applications. Each channel can be set individually except when operating in mono bridge mode where only channel A volume control is active.

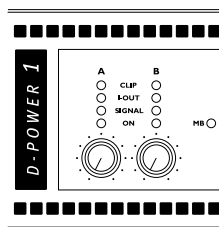

Set the volume to zero before turning on the amplifier to prevent the occurrence of sudden high volume levels which may cause damage to your hearing and/or the speakers.

4.1.2 Mode Selector

The switch on the rear panel offers the selection of the operating mode between Dual Channel (Stereo) and Mono Bridge.

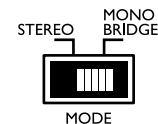

4.1.3 Dual Channel Operation (Stereo)

Two fully independent amplifier channels (normal operating mode).

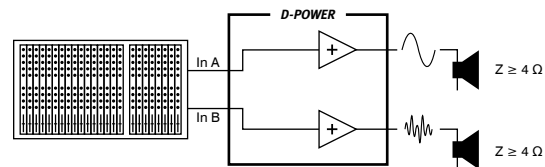

4.1.4 Mono Bridge Operation

One-channel mono bridged operation.

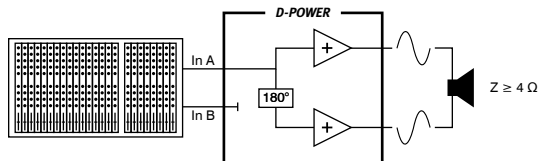

The second amplifier channel processes the same input signal, but with reversed phase. The (single) load is connected between the two positive channel outputs using a suitable connected SPEAKON® connector (see below). While the total output of the amplifier remains the same, both the available output voltage and the minimum impedance that can be connected are doubled, as compared with stereo operation. Only channel A-Input is active. A signal feeding channel B will have no effect on the output. Turn the volume of channel B down to zero.

To connect loudspeakers in Mono Bridge always attach the loudspeaker between:

Pin 1+ and 2- on the upper SPEAKON® or

Pin 2+ and 1- on the lower SPEAKON® connectors

See also chapter 3.4.2!

WARNING !

In Mono Bridge mode RMS output voltages are as high as 125 V. Wiring to the speaker loads must conform to NEC Class 2 safety standards or its equivalent that meets all national and local electric codes.

All customer specific cables may only be manufactured by qualified suppliers/personnel. All cabling or rewiring work must be carried out by qualified personnel.

4.2 Indicators

4.2.1 On LEDs

Under normal operation, after the amp has started, the green power LEDs are permanently lit.

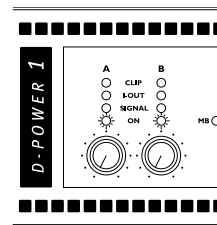

4.2.2 Signal/Protect LEDs (multifunctional)

The green Signal LEDs are illuminated when the voltage level at the output reaches approx. 4 V; this corresponds to a power of approx. 4 W into a 4 Ohm load. The channel signal LEDs are illuminated red when the amplifier is in Protect Mode (Mute), for example because of persistent DC-voltage at the outputs or overheating.

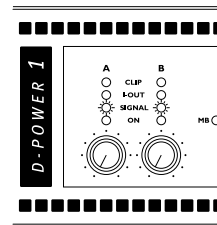

4.2.3 Output Current LEDs

The brightness is proportional to the output current in the corresponding channel.

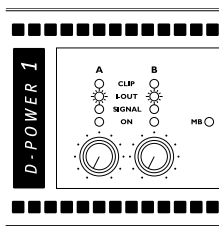

4.2.5 Mono Bridge Mode Indicator

On the front panel there is a yellow LED to indicate if the Mono Bridge Mode is set. In Dual Channel (Stereo) Mode the LED will not be lit.

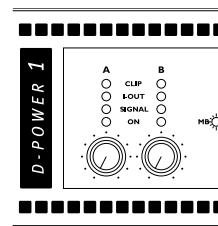

4.2.4 Clip LEDs (multifunctional)

The colour of the bi-coloured LED changes between orange and red, depending on the clip intensity. Orange indicates light clipping, red indicates heavy clipping.

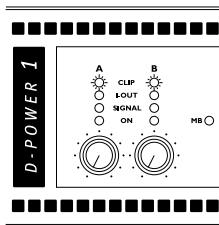

4.3 Power Amp Protection Systems

4.3.1 Clip Limiter

If the power amp is overdriven, the clip limiter automatically reduces the output level to reduce the audible clipping.

4.3.2 DC Protection

Each output of the power amp is constantly monitored for persistent DC voltage levels. If the 3 V thresholds are exceeded at any of the outputs, the corresponding channel will be muted. If DC was only detected for a short moment, the amplifier will release mute and work as normal.

4.3.3 Over Current Protection

Over current is permanently controlled in the output stage.

4.3.4 Thermal Protection

A sensor on the amplifier heatsink constantly monitors the temperature. If a temperature of more than 85 °C is detected at the heat sinks, the input signal on that channel is reduced. If the temperature exceeds 95 °C, the main SMPS will be switched off.

NOTE: Due to the construction, the four fixing screws of the amplifier power stage can get very hot even under normal operation (up to 70 °C). This does not indicate a failure, the amplifier works correctly.

4.4 Mains Protections

4.4.1 Inrush Current Limitation

Within 2 seconds of the amplifier being switched on, the inrush current limiter will increase mains current from nearly zero to nominal value. This value depends on program material, output level and speaker loads.

4.4.2 Mains Over Voltage Detection

Mains over voltage detection is always operative. When the mains voltage exceeds approx. 265 V (230 V operation) or 138 V (120 V operation), the amplifier will be switched off. The system will try to restart in intervals and will return with a soft start when the regular mains voltage returns.

4.5 Main SMPS Protections

4.5.1 Over Current Protection

Main SMPS (Switched Mode Power Supply) transformer current is continuously monitored. If over current occurs, the main SMPS immediately stops working. Should there be an internal failure, this feature prevents other parts being damaged.

4.6 Fan

The fan mounted in the **D-POWER** will be disabled as long as the internal heatsink temperature is lower than 60 °C. At higher temperatures the fan will be activated providing improved cooling to the amplifier. Once running the fan will be switched off again at temperatures lower than 40 °C.

4.7 Filter Cleaning

The air intake on the front of your *D-POWER* Amplifier is fitted with a removable filter system. If the filter becomes clogged, the unit will not cool as efficiently as it should and may result in reduced output levels.

WARNING: Disconnect the amplifier from the mains before removing the front frame.

To clean or replace the filter just slightly unscrew the fixing screw with the help of a 3 mm allen key. The screw will be held back by a small plastic spacer on the back of the frame to avoid losing it. Then shift the front frame slightly to the right. Then you should be able to remove the frame from the amplifier completely (pull gently to avoid any bending of the front frame).

D-POWER Filter Assembly

- 1 Foam Filter
- 2 Front Frame
- 3 Screw

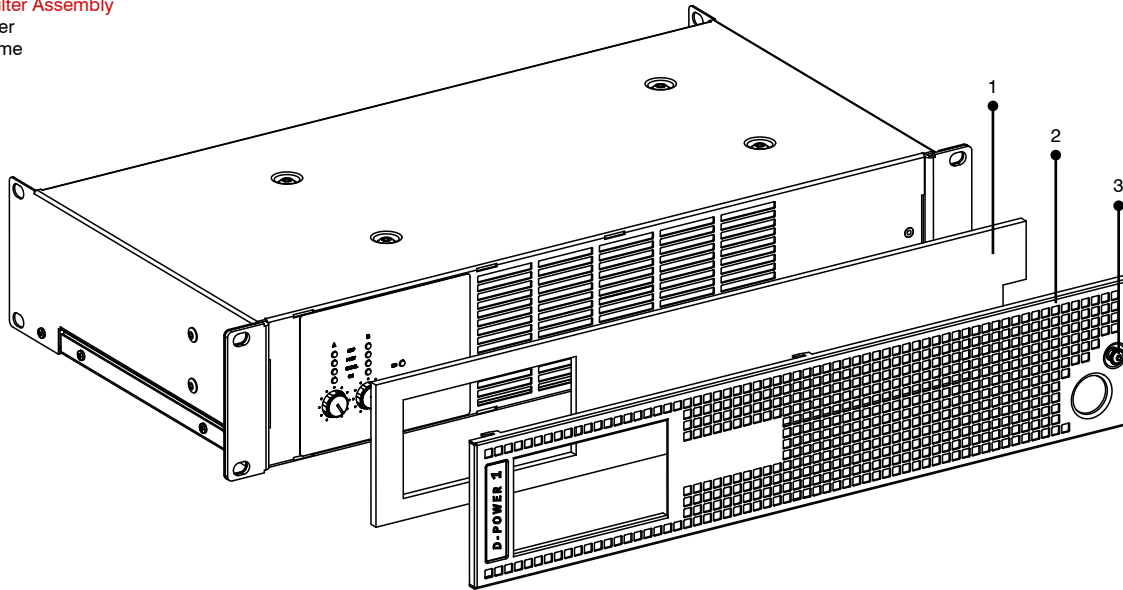

5.1 Problem: No Sound**Indication:**

On LEDs not lit
Signal LEDs not lit
Clip LEDs not lit

- Check AC plug.
- Confirm that AC outlet works by plugging in another device.

Indication:

I-Out LEDs are lit

Signal LEDs not lit

- Make sure the signal source is operating and try another cable.
- Check position of volume pots.

Indication:

I-Out LEDs are lit

Signal LEDs responding to signal level

- Check the speaker wiring for breaks.
- Try another speaker and cable.

Indication:

Signal LEDs show red (Protect Mode)

- Overheating will cause protective muting. Check for proper ventilation.

5.2 Problem: No Channel Separation

- Check the mode indicators on the front panel and make sure the mode selector on the rear panel is in the stereo-position.
- Make sure other equipment in the signal path such as mixers and preamps are set for stereo, not mono.

5.3 Problem: Distorted Sound**Indication:**

I-Out LEDs are lit
Signal LEDs responding to signal level
Clip LEDs not lit

- A faulty speaker or a loose connection could cause this. Check the wiring and try another speaker.
- The signal source might be clipping. Keep the **D-POWER** volume pots at least halfway up so that the source does not have to be overdriven.

5.4 Problem: Hiss

- Unplug the amplifier input to confirm that the hiss is coming from the source or from a device upstream. Erratic or popping noises indicate an electronic fault in the offending unit.
- To keep the noise floor low, operate the primary signal source at full level, without clipping.
- Avoid boosting the signal further between the source and the amplifier.

5.5 Problem: Squeals and Feedback

- Microphone feedback should be eliminated with mixer controls. If noise continues to build up with no microphone gain, there is a serious fault in the signal processors or cables. Working in succession from the signal source towards the amplifier and check each device in the signal path by reducing its gain or by unplugging it.

	D-POWER 05	D-POWER 1
Output Power 1 kHz, THD ≤ 1 %, in dual channel operation duration limited by thermal protection	2 x 250 W @ 4 Ω 2 x 125 W @ 8 Ω	2 x 500 W @ 4 Ω 2 x 250 W @ 8 Ω
Peak Output Power 1 kHz, single sine wave in dual channel operation	480 W @ 4 Ω 240 W @ 8 Ω	800 W @ 4 Ω 400 W @ 8 Ω
Output Power Mono Bridge 1 kHz, THD ≤ 1 % duration limited by thermal protection	1 x 500 W @ 8 Ω 1 x 250 W @ 16 Ω	1 x 1000 W @ 8 Ω 1 x 500 W @ 16 Ω
Circuitry	MOSFET, Class D	
Signal to Noise-Ratio 20 Hz - 20 kHz, 8 Ω load, unweighted A-weighted	> 110 dB > 114 dB	> 111 dB > 115 dB
Power consumption @ 230 V Idle Amp switched on, no signal		0,3 A 23 W
Typical @ 1/6 of max output power with pink noise to represent typical music signal, both channels driven	1,0 A 120 W	1,6 A 200 W
Maximum output voltage in dual channel operation	±62 V peak	±80 V peak

Minimum Loudspeaker Load Impedance

lower values are safe, but out of specification

Frequency Response8 Ω load with 50 W output power**THD+N (typical)**20 Hz - 6 kHz, 8 Ω load, with 50 W output power**SMPTE (typical)**8 Ω load, 10 dB below rated power**Damping Factor**8 Ω load, 1 kHz and below**Input Impedance****Voltage Gain****Protection Circuits****Limiter****Cooling****Operating Temperature****Indicators****Input Connectors****Output Connectors****Modes of Operation****AC mains****Dimensions (WxHxD)****Net Weight****Shipping Dimensions (WxHxD)****Shipping Weight**Zmin = 4 Ω for Dual Channel operationZmin = 8 Ω for Mono Bridge operation

20 Hz - 20 kHz +0 dB/-0,5 dB

< 0,05 %

< 0,01 %

> 400

14 k Ω balanced

26 dB

Inrush-current limitation, temperature monitoring of heatsink, output DC protection, output over current protection, SMPS over current protection

Fixed clip limiter

One temperature dependent axial fan

0° C - 50° C

LEDs for Power-ON, Signal/Protect, Output Current, Clip and Mono Bridge

Two 3-pin XLR female/6,3 mm Jack hybrid connectors, pin 2 = inphase (hot)

Two 6,3 mm Jack connectors, tip = inphase (hot)

Two 4-pole SPEAKON® connectors, one for each output channel (bi-amping possible)

Dual Channel (Stereo), Mono Bridge

Dual-voltage SMPS with automatic voltage range selection 230 V/120 V, 50-60Hz

Operating voltages: 230 V range: 170-265 V, 120 V range: 85-138 V

483 x 88,1 x 250 mm (19", 2U)

5,7 kg

540 x 135 x 390 mm (0,028 m²)

7,1 kg

We reserve the right to make technical alterations without prior notice

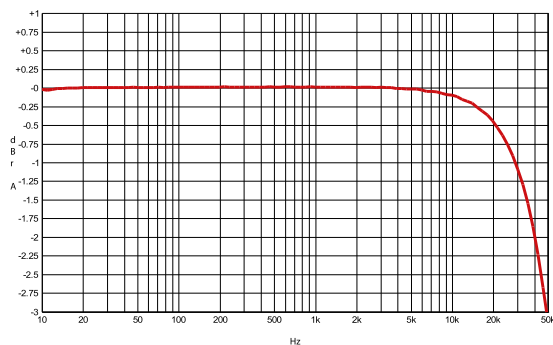

Figure 7.1
Gain vs. frequency, 50 W output power, 8 Ω
(Measurement of a typical performance)

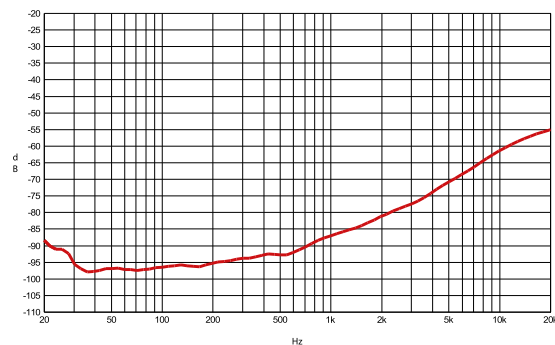

Figure 7.3
THD vs. frequency, 50 W output power, 8 Ω
(Measurement of a typical performance)

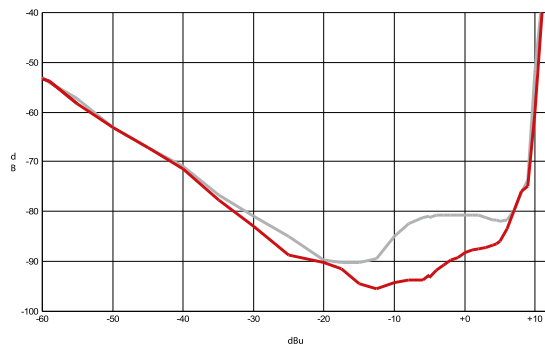

Figure 7.2
THD @ 1 kHz vs. input voltage (8 Ω , 4 Ω)
(Measurement of a typical performance of D-POWER 1)

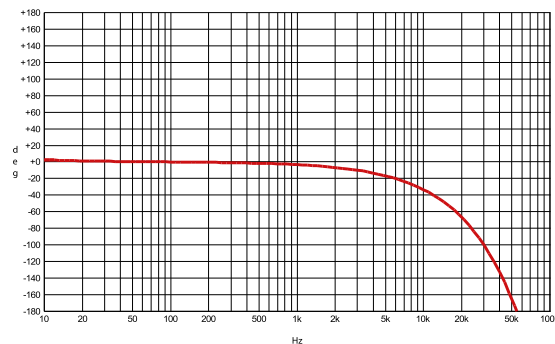

Figure 7.4
Phase vs. frequency
(Measurement of a typical performance)

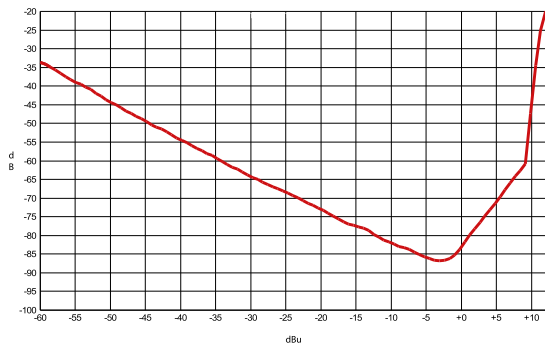

Figure 7.5
SMPTE 4:1, 60 Hz, 7 kHz vs. input level
(Measurement of a typical performance of **D-POWER 1**)

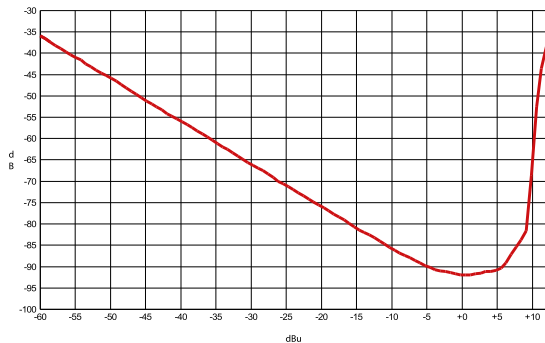

Figure 7.6
DIM 100 intermodulation distortion @ 8 Ω vs. input level
(Measurement of a typical performance of **D-POWER 1**)

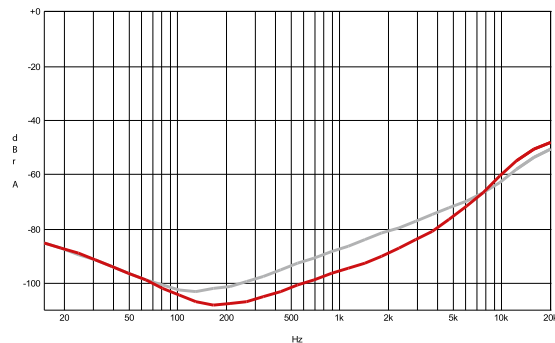

Figure 7.7
Channel separation vs. frequency @ 50 W / 8 Ω (channel 1, channel 2)
(Measurement of a typical performance)

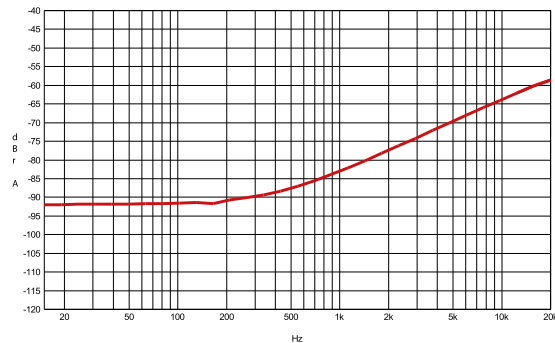
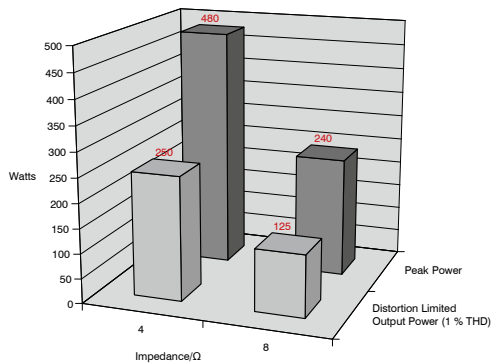
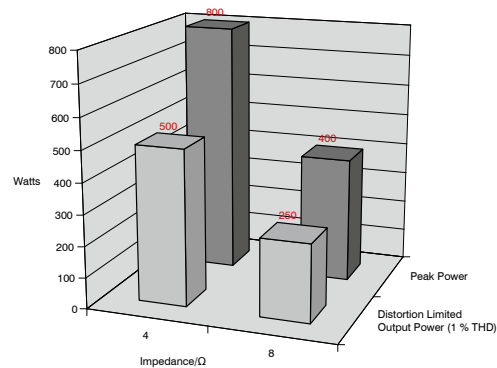

Figure 7.8
Common mode rejection ratio
(Measurement of a typical performance)

D-POWER 05



D-POWER 1



8.1 Summary of Warranty

CAMCO guarantees the **D-POWER 7** Amplifier to be free from defective material and/or workmanship for a period of six (6) years from the date of sale. When a defect occurs under normal installation and use, **CAMCO** will repair the product under this warranty. In this event, please return the amplifier to your dealer/distributor together with a copy of your sales receipt as proof of purchase.

This warranty provides that examination of the returned product must indicate in our judgement a manufacturing defect.

8.2 Items Excluded from This Warranty

CAMCO is not liable for any damage caused by shipping accidents, misuse, abuse, operation with incorrect AC voltage, operation with faulty peripheral equipment, modification or alteration without prior factory approval, service by an unauthorized service center and normal wear and tear. Amplifiers on which the serial number has been removed or defaced are not eligible for warranty service.

8.3 What **CAMCO** Will Do

CAMCO (or its appointed agent) undertakes to rectify any defect regardless of the reason for failure (unless excluded from this warranty), by repair, replacement or refund as it sees fit.

8.4 How to Obtain Warranty Service

You must notify your dealer/distributor of your need for warranty service. All components must be shipped in the original packaging.

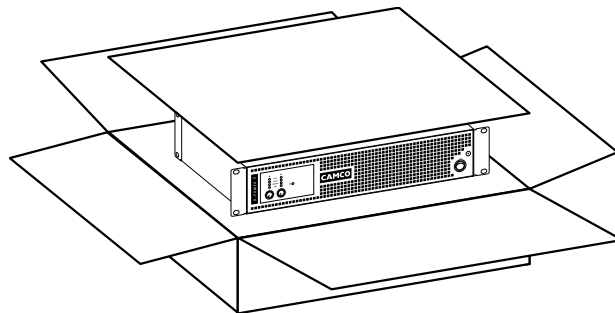

8.5 **CAMCO**'s Product Improvement

CAMCO reserves the right to improve the technical standard of its products without giving prior notice. If in any doubt, please consult your dealer/distributor or contact **CAMCO** directly for clarification.

**PLEASE ENCLOSE THIS COMPLETED FORM WITH THE AMPLIFIER
DO NOT SEND SEPARATELY**

Owner's Information

Company Name: _____

Contact: _____

Address: _____

Telephone: _____

Facsimile: _____

eMail Address: _____

Model: _____

Serial Number: _____

Purchase Date: _____

Nature of problem occurred

Please describe the conditions that existed when the problem occurred and what attempts were made to correct it:

Expired Warranty

If the warranty has expired, payment will be:

Cash/Cheque

VISA

MasterCard

Other equipment in your system: _____

CAMCO Produktions- und Vertriebs-GmbH für Beschallungs- und Beleuchtungsanlagen, Fischpicke 5, D-57482 Wenden, Germany



10 Maintenance Information

Cleaning and servicing the inside of the amplifier must never be carried out by unqualified personnel. The amplifier must never be opened by unqualified personnel.

Cleaning and servicing work on the inside of the amplifier must only be carried out by qualified personnel.

Qualified personnel is defined as a person who has gained specialised relevant knowledge of electronic engineering through education, training, and experience, and who has sufficient knowledge of all relevant governmental work safety regulations to be in a position to judge the safe functioning of power amplifiers based on technical rules according to IEC 60065 (IEC 60065 (DIN EN 60065) "Safety Requirements for Audio, Video or similar Electronic Appliances").

In order to guarantee the safe functioning of the amplifier, it has to be checked regularly, depending on its application but at least once a year, by a properly qualified person.

Advice on how to carry out these checks can be found in DIN VDE 0702-1 "Safety Checks for Electronic Appliances" .

An amplifier that is considered to be unsafe must be labelled accordingly and stored in a safe place to prevent this amplifier being used mistakenly.

11 Decommissioning

During the decommissioning process of the amplifier, all legally prescribed rules and procedures must be adhered to.

Mailing Address:

CAMCO Produktions- und Vertriebs-GmbH
für Beschallungs- und Beleuchtungsanlagen
Fischpicke 5
D-57482 Wenden
Germany

Telephone:

+49 (0) 2762 408-0

Facsimile:

+49 (0) 2762 408-10

Internet:

www.camcoaudio.com

Email:

postmaster@camcoaudio.com

CAMCO

www.camcoaudio.com