

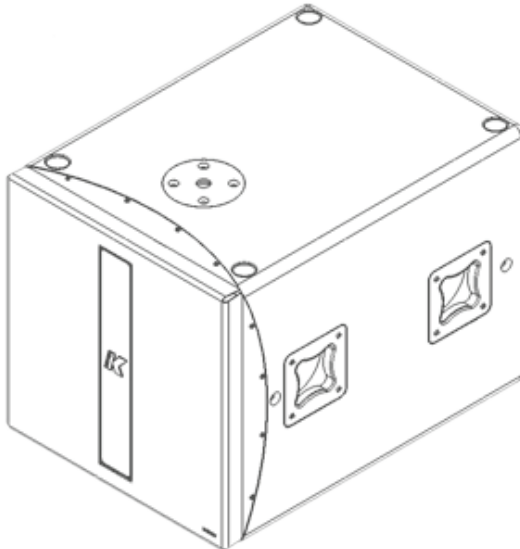

*Redline*  
**KMT21**  
USER'S MANUAL  
*English*





## Contents

<b>SYMBOLS</b>	<b>5</b>
<b>1. INTRODUCTION</b>	<b>7</b>
<b>2. APPLICATIONS</b>	<b>7</b>
<b>3. KEY FEATURES</b>	<b>7</b>
<b>4. UNPACKING</b>	<b>8</b>
<b>5. WARRANTY</b>	<b>8</b>
<b>6. SAFETY</b>	<b>8</b>
<b>7. PHYSICAL</b>	<b>9</b>
<b>8. AMPLIFIER</b>	<b>10</b>
8.1 AC POWER CONNECTOR	10
8.2 VOLTAGE REQUIREMENT	10
8.3 CURRENT REQUIREMENT	10
8.4 REAR PANEL	11
8.5 TOUCH SCREEN FUNCTIONS	13
8.6 AUDIO INPUT CONNECTOR WIRING	14
8.7 AMPLIFICATION AND PROTECTION CIRCUITRY	14
<b>9. K-FRAMEWORK</b>	<b>15</b>
9.1 SYSTEM REQUIREMENTS	15
9.2 INSTALLATION AND SETUP	15
9.4 USER TABS:	18
INPUT TAB	19
ROUTING TAB	20
DELAY TAB	20
OUTPUT TAB	21
<b>10. SERVICE</b>	<b>22</b>
<b>11. SPECIFICATIONS</b>	<b>23</b>
<b>12. DECLARATION OF CONFORMITY</b>	<b>24</b>



**SYMBOLS**

---



K-array declares that this device is in compliance with applicable CE standards and regulations. Before putting the device into operation, please observe the respective country-specific regulations!

---

**WEEE**

Please dispose of this product at the end of its operational lifetime by bringing it to your local collection point or recycling center for such equipment.

---



This symbol alerts the user to the presence of recommendations about the product's use and maintenance.

---



Warning! Dangerous voltages: RISK of electric shock.

---



This symbol alerts the user to the presence of recommendations about product's use and maintenance.

---



This device complies with Restriction of Hazardous Substances Directive.

---



## 1. INTRODUCTION

---

The K-array KMT21 is a full-featured audio system, featuring a 21" powered subwoofer, programmable on-board DSP and multiple analog and digital inputs and outputs for creating a wide array of speaker configurations.

The KMT 21 features an integrated touch screen, providing intuitive control over the main DSP functions: input / output levels, signal routing, offset delays for subwoofer and speakon output (up to 12 ms., each) and overall system delay (up to 330 ms.). All DSP functions, including EQ, can also be remote controlled via software over USB or RS485 (3-pin XLR).

The KMT series provides two balanced analog line level inputs and a two-channel AES/EBU digital input. An integrated class D amplifier delivers 2 x 2000 W at 4Ω, with a max THD of 1% (EIAJ test @ 1KHz). The KMT21 features multiple analog and digital outputs, including a Speakon output to connect a wide array of passive speakers including mid-high modules (KP52, KP102) or additional passive subwoofers (KMT21P). To optimize performance, the on-board DSP includes up to 40 programmable presets. The first 8 have been designed by K-array, the additional 32 slots can be used to create, save, and store personal presets using the K-framework software.

The KMT series' unique four-corner port configuration provides symmetrical back loading to the speakers, for extended bass response with very low distortion. The port configuration also provides incredible structural strength to the cabinet, despite its light weight. Pocket handles and an M20 thread mount position for attaching mid-high speakers makes the Redline series convenient to use and ideal for medium throw applications in theaters, concert halls, and Audio/Video installations.

All KMT components are designed by K-array and custom-made under K-array's quality control system.

## 2. APPLICATIONS

---

- Theatrical sound reinforcement
- Concert halls, clubs, houses of worship
- Portable and installed audio-visual systems
- Cinema and special effects

## 3. KEY FEATURES

---

- Unique performance-to-size ratio
- Direct radiating, long excursion driver
- Ultra fast set-up and dismantling system
- Fitted with integrated handles and castors
- Analog and digital AES/EBU inputs
- Remote software control over USB and RS485
- Optimized for use with KP52 / KP102, KMT21P

## 4. UNPACKING

---

Each K-array loudspeaker is built to the highest standard and thoroughly inspected before leaving the factory. Upon arrival, carefully inspect the shipping carton, then examine and test your new loudspeaker. If you find any damage, immediately notify the shipping company. Only the consignee may institute a claim procedure regarding the system's electronic equipment.

## 5. WARRANTY

---

K-array systems are warranted against manufacturing defects in materials or craftsmanship over a period of 2 years from the date of original purchase. During the warranty period K-array will, at its discretion, either repair or replace products which prove to be defective provided that the product is returned in its original packaging, shipping prepaid, to an authorized K-array service agent or distributor. K-array cannot be held responsible for defects caused by unauthorized modifications, improper use, negligence, exposure to inclement weather conditions, acts of God or accidents, or any use of this product that is not in accordance with the instructions provided by K-array. K-array is not liable for consequential damages. This warranty is exclusive and no other warranty is expressed or implied. This warranty does not affect your statutory rights.

## 6. SAFETY

---



### WARNING



- Professional loudspeakers are capable of producing extremely high sound levels and should be used with care. Hearing loss is cumulative and can result from extended exposure to levels in excess of 90dB.
- Always use loudspeaker systems in a safe manner. Never stand close to loudspeakers driven at high volume.
- Only install the speaker in a location that can structurally support the weight of the unit. Doing otherwise may result in personal injury and property damage.
- The system should only be suspended by qualified personnel, following safe rigging practices. If there is any doubt, seek professional help from architects, structural engineers or other specialists before proceeding.
- Do not operate the speaker for an extended period of time if the sound is distorted. This is an indication of malfunction, which can cause heat build-up and result in a fire.
- Only connect the power supply to an appropriate power adapter.
- Do not install the speaker in wet or humid locations without using weather protection.
- Do not allow water or any foreign object to get inside the speaker. Do not put objects containing liquid on, or near, the unit.
- To reduce the risk of overheating the amplifier, avoid exposing it to direct sunlight. Do not install the unit near heat emitting appliances, such as a room heater or stove.
- Never place open flame sources, such as lighted candles, near the device.
- The speaker should be placed in a location that does not interfere with its proper cooling.
- Do not attempt to disassemble the unit. The unit contains no user-serviceable parts. Repairs should be performed only by factory trained service personnel.
- Be sure that the adapter has the correct voltage value.



7. PHYSICAL

---

# KMT21

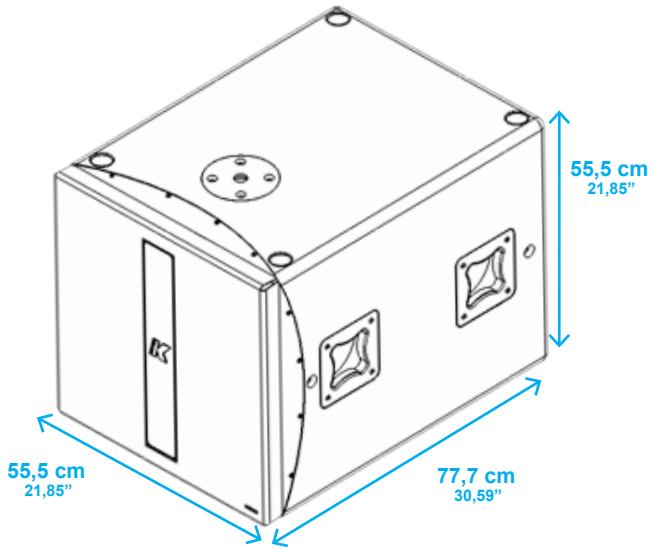

**weight: 49 kg (103.03 lbs)**

## 8. AMPLIFIER

---

### 8.1 AC POWER CONNECTOR

The amplifier module and any audio equipment connected to it (mixing consoles, processors, etc.) must be properly connected to the AC power distribution, preserving AC line polarity. All grounding points should be connected to a single node or common point, using the same cable gauge as the neutral and line cables. Bad grounding connections within an audio system can produce noise, hum and/or serious damage to the input/output stages in the system's electronic equipment.



Before applying AC to any K-array self-powered speaker, be sure that the voltage potential difference between neutral and earth ground is less than 5 VAC.

### 8.2 VOLTAGE REQUIREMENT

The KMT21 will operate safely, without interruption, provided the AC voltage remains within 85V- 268V, at 50 or 60 Hz. Please verify that your AC mains connection is capable of satisfying the power ratings for the device.

#### CAUTION

Do not connect the system to AC power mains exceeding 270V. Doing so will cause significant damage to the device and create serious risk for users!



### 8.3 CURRENT REQUIREMENT

The KMT21 presents a dynamic load to the AC mains, drawing additional current as operating levels increase. Different cables and circuit breakers heat up at varying rates, so it is essential to understand current ratings and how they correspond to circuit breaker and cable specifications. Maximum continuous RMS current - measured over a period of at least ten seconds - is used to calculate the temperature increase in cables, which drives the proper size and gauge cable and rating for slow-reacting thermal breakers. Maximum burst RMS current - measured over a period of approximately one second - is used to select the rating for fast reacting magnetic breakers.

For best performance, voltage drops should not exceed 10% at 115V or 5% at 230V.

The minimum electrical service amperage required by a K-array loudspeakers system is the sum of their maximum continuous RMS current. We recommend allowing an additional 30% above the minimum amperage to prevent peak voltage drops at the service entry.

**KMT21 max continuous apparent power (VA)**  
**670VA(>10 sec) - 2600VA (<1 sec)**

8.4 REAR PANEL

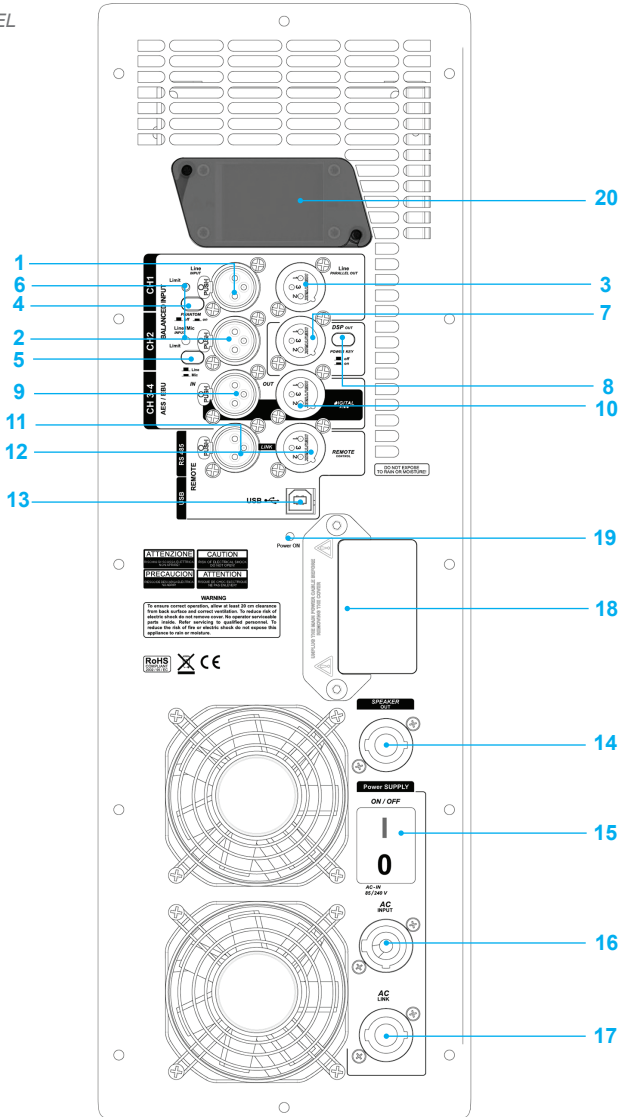

- 1) CH1 Line Input. XLR line level input with +4 dBu sensitivity.
- 2) CH2 Mic/Line Input. XLR input, with selectable sensitivity for Mic (-30 dBu) or Line (+4 dBu).
- 3) CH1 Parallel Line Out. XLR parallel output, providing a direct signal from the CH1 Line Input. This output cannot be processed or controlled via the K-Framework software
- 4) Phantom Power switch. Turns phantom power (48V) on/off on CH1 and CH2 inputs.
- 5) Mic/Line switch. Selects CH2 input sensitivity for Mic (-30 dBu) or Line (+4 dBu) level..
- 6) Limiting LEDs. Independent LEDs for the CH1 and CH2 inputs, which blink when the optical limiter engages to protect the corresponding preamp circuit. Limiter threshold is +5 dBu.
- 7) DSP Out. Auxiliary XLR balanced output, controlled via the K-Framework software. Users can select the signal routed to this output and manage its amplitude and EQ individually.
- 8) DSP Out Power switch. Turns phantom power (48V) on and off on the DSP out. Phantom power can be engaged to drive additional wireless signal transmitters/receivers.
- 9) AES/EBU Digital Input. XLR input connector for two-channel AES/EBU digital audio, accepting sample rates from 32 kHz – 96 kHz.
- 10) AES/EBU Digital Output. XLR output, providing two-channel digital audio from AES/EBU Input, at a sample rate of 48 kHz. This output cannot be processed or controlled via the K-Framework software.
- 11) REMOTE RS485 Link Input. XLR input for connecting the KMT from another RS485 device in a K-Framework network. RS485 Link Input can also be used to connect a computer running the K-Framework software (requires K-USB USB-to-RS485 adapter).
- 12) REMOTE RS485 Link Output. XLR output for connecting additional RS485 devices in a K-Framework network.
- 13) REMOTE USB Input. Connects a computer running the K-Framework software, for remote control of the KMT. Users can manage an entire network of RS485 devices with one PC connected via USB (see RS485 Network diagram, below).
- 14) Speaker Out. Powered Speakon output, used to drive passive speakers, like a KP series mid-high module or a KMT series passive subwoofer
- 15) Power switch. This switch turns the KMT system on and off.
- 16) AC Input. Powercon input for AC power. See p. 11 for voltage and power requirements.
- 17) AC Link. Powercon output for feeding AC mains power to additional K-array components with a powercon AC input socket.
- 18) Extension Connector. Multi-pin connector for various K-array extension modules, for wireless control and audio transmission, memory extension, digital signal encoding and audio reproduction.
- 19) Power On LED. Indicates the system is ON.
- 20) TOUCH SCREEN Control panel. Provides access to the main functions of the DSP on board (see Section 8.5)

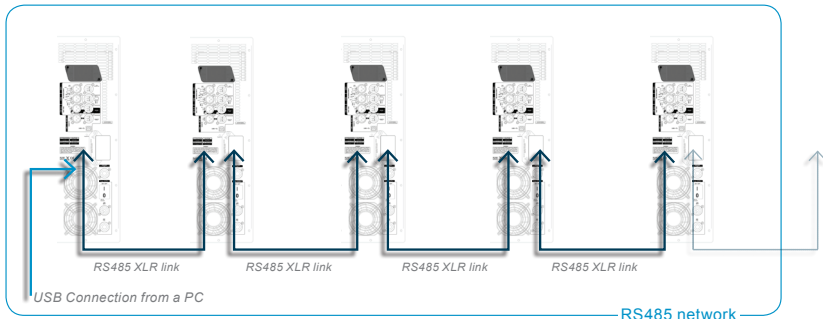

## 8.5 TOUCH SCREEN FUNCTIONS



The main functions of the onboard DSP can be managed with the integrated touch screen. Functions are grouped into six pages, shown as icons on the Home page.



To reach the Home page from any other page, touch the Home button.

## INPUT PAGE



The Input page allows users to independently manage the amplitude of all the four input channels

## OUTPUT PAGE



The Output page allows users to independently control the amplitude of the signal routed to the Subwoofer, the Speaker Output and the XLR DSP Output.

## ROUTING PAGES



Three Routing pages allow users to manage the routing of the four input channels to the three outputs (Subwoofer, Speaker Out and XLR DSP Out) as well independently set output volume and delay for each output.

The delay values set in the Routing pages are summed to the global delay assigned on the Delay page.



The arrow buttons on the top right corner of the screen provide access to individual Routing pages for the Subwoofer, Speaker Out and XLR DSP Out.

Notes: The XLR DSP page does not provide control over delay for this output.

## PRESET PAGES



Two Preset pages allow users to load presets stored on-board. The arrow buttons on the top right corner of the screen provide access to the Factory and User preset pages. The arrows are also used to scroll through, select and load one of the available presets.

## INFO PAGE



The Info page contains information about the current software and firmware, and the Logical ID of the KMT module. The Logical ID is automatically assigned to the KMT unit when connected to a K-Framework network.

**DELAY PAGE**

The Delay page allows users to independently set the delays for the speaker system (Subwoofer and Speaker Out). This delay is summed with the delays from the Routing pages of Subwoofer and Speaker Out. The COARSE and FINE controls allow users to change the delay in larger and smaller steps.

**Notes: The delay control does not affect the XLR DSP out. Delay for this output line can only be managed through the K-Framework dedicated controls.**

### 8.6 AUDIO INPUT CONNECTOR WIRING

The Audio section includes parallel LINK, which allows users to distribute an audio signal to multiple units. Up to 30 different modules can be connected in parallel on the same balanced line (with a source output impedance of 600 ohm).

CH 1 Line Input (female, balanced XLR) is wired in parallel to CH1 Line Parallel Out (male, balanced XLR). To create your own audio cables, please use the following wiring diagrams:

#### *XLR connector*

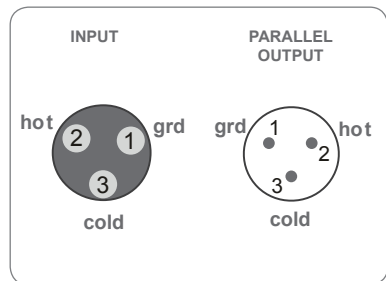

### 8.7 AMPLIFICATION AND PROTECTION CIRCUITRY

The KMT21 is powered by a 2-channel digital amplifier with 2000 W output power per channel (EIAJ test).

The KMT21's amplifier functions, including crossovers, equalization, phase response, and driver protection, are controlled by an on-board DSP processor.

KMT series amplifiers are equipped with several protection circuits to prevent damage. Two independent audio limiters – Clip Limiter and Average Power Limiter – protect the internal circuitry against overload. A Peak Current Shut Down protects the output stage with a tripping point at 35A. If tripped, Peak Current Shut Down will reset after 2 seconds. A Temperature Protection Limiter also ensures the output stage stays below a temperature of 85° C (approximate temperature of output power device).

## 9. K-FRAMEWORK

### 9.1 SYSTEM REQUIREMENTS

#### SYSTEM REQUIREMENTS:

Operating System: Windows XP / Vista / 7

CPU: Intel Pentium Dual Core

Memory: 2 GB

#### REQUIRED COMPONENTS:

Microsoft .NET Framework 4:

<http://www.microsoft.com/download/en/details.aspx?id=17718>

Microsoft Visual C++ 2010 Redistributable Package (x86):

<http://www.microsoft.com/download/en/details.aspx?id=5555>

Microsoft Visual C++ 2010 Redistributable Package (x64):

<http://www.microsoft.com/download/en/details.aspx?id=14632>

### 9.2 INSTALLATION AND SETUP

To download your free K-Framework software, please navigate to the K-array "Software Download" page located at <http://usa.k-array.com/en/download/software.html>

Download the latest 32- or 64-bit installer. Decompress the .zip file and extract the "K-Framework.setup" installer file.

- Windows Vista and Windows 7 users can install the software by simply running the K-Framework.setup file.

- Windows XP users are required to install the necessary USB drivers separately:

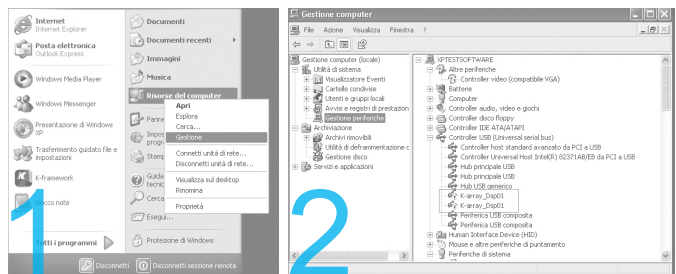

- 1) Open the "Control Panel" menu from the "Start Menu" or "My Computer."
- 2) Open "Device Manager" from the Control Panel and expand the "USB controllers" (or "Universal Serial Bus controllers") sub-menu.

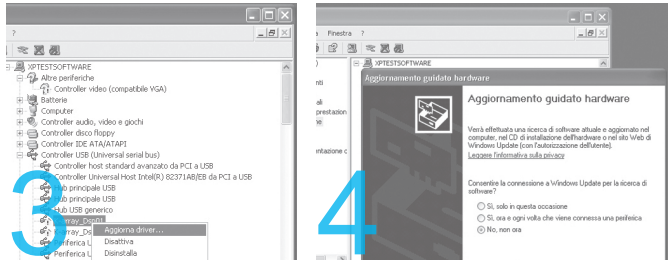

- 3) Right click on the upper "K-Array\_Dsp01" object and select "Driver Update" to launch the "Hardware Update Wizard"
- 4) When asked to allow the online search, select "Not now" and click "Next."
- 5) When asked for the driver's location, select "Install from a list or specific location."
- 6) In the search and installation options window, select "Search for the best driver in this location" and check the "Include this location in the search" checkbox, then browse for the driver's folder. The path should read:

C:\ProgramFiles\K-array\K-framework\drivers\_rev02

Select the new driver file and click "Next."

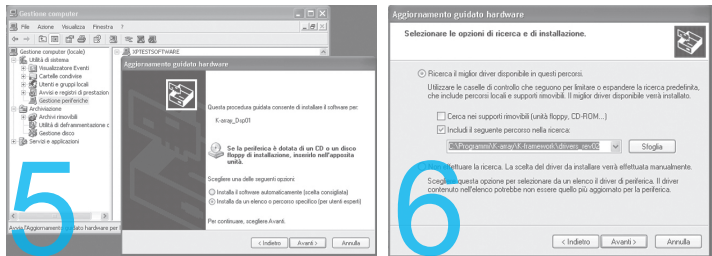

- 7) If warned about a failed "Windows Logo" test, please ignore and click "Next".
- 8) The first part of driver installation is now complete, and the "unknown" K-Array\_Dsp01 port has been updated to read "K-Array\_Dsp01 A." Click on "Finish" and repeat the same procedure for the second driver.
- 9) Now you can see that inside the Device Manager Window both devices now have unique names (K-Array\_Dsp01 A and K-Array\_Dsp01 B), and the alert symbol is no longer present. You are now 100% ready to get started!





At startup K-Framework will show the following window:



img. A

**A1)** Connected Devices Indicator shows the number of detected connected devices. N.B.: At startup, the indicator will show 0 devices, even if one or more units are connected. To detect all connected devices, click the “Connect” button (A2).

**A2)** Connect Button detects connected devices.

**A3)** Demo Button activates the demo mode of K-Framework. In this mode, all devices that can be managed with the K-Framework software appear in the Connected Devices Menu on the left, so that the user can navigate through all the dedicated tabs and have a glimpse of the different functions available for each unit.

**A4)** K-array Device List displays all devices presently connected to the network.

N.B.: at startup the List will be empty, even if one or more units are connected. To detect all connected devices, just click the “Connect” button (A2).

**A5)** Account Button opens the Account Settings Window where users can insert User Name and Password to access the K-Array Community and the shared preset database.

**A6)** Zoom Buttons zoom in (+) and out (-) of the window view.

Click the Connect button to detect all presently connected devices.

All detected devices will appear in the K-Array Device list, as shown in Image B (below):

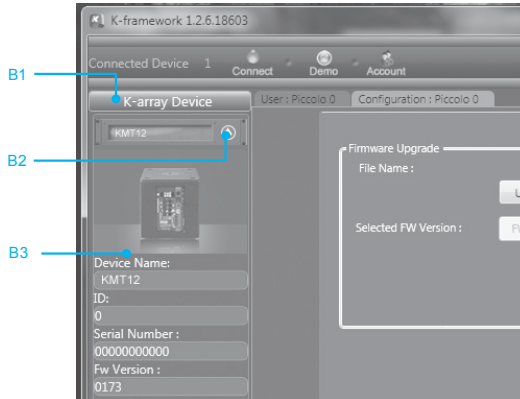

img. B

- B1) Connected Device Name.
- B2) Device Menu Button shows and hides the device menu.
- B3) Device Menu displays the basic information about the device and the shortcuts to open all available Editing Tabs.

#### 9.4 USER TABS:

HOME

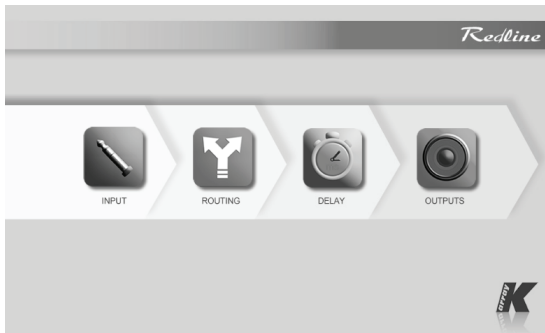

img. C

From the Home window, users can access the dedicated tabs, which follow the signal flow from input stage to output stage.

## INPUT TAB

Allows users to independently manage the EQ and gain of the four input channels

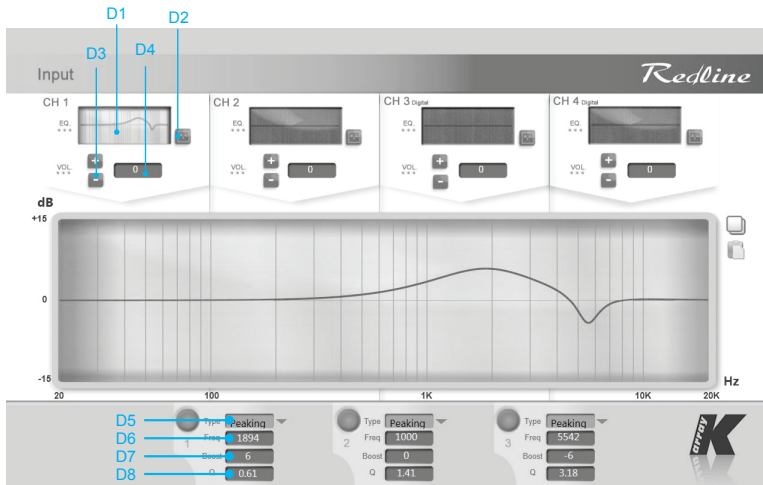

img. D

**D1)** Frequency response display. Shows the frequency response curve resulting from the filters set in the Input EQ window (below).

**D2)** Input EQ window button. Opens the Input EQ window, where users can set three parametric filters for each input channel. Input Volume buttons. They regulate the amplitude of each input channel

**D3)** Input Volume buttons. Adjusts the amplitude of the input channel

### Input EQ window

**D4)** Input Volume display. Shows the gain or reduction currently applied to the channel. Users can directly set the desired amount of gain in the Input Volume display, instead of using the Input Volume buttons

**D5)** Filter type menu

**D6)** Filter frequency

**D7)** Filter Q

**D8)** Filter boost

## ROUTING TAB

**E1)** Routing switch button. When lighted, the signal coming from the corresponding input on the left column is routed to the corresponding output on the top row.



img. E

## DELAY TAB

Allows users to independently manage the delay applied to the three output channels.

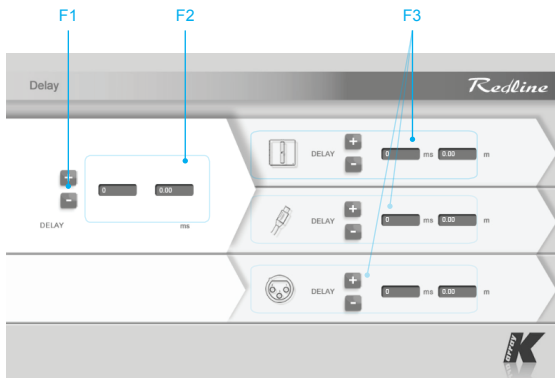

img. F

**F1)** Global Delay buttons. Adjusts the amount of overall delay applied to both the subwoofer and speaker output (which can feed passive speakers, i.e.: mid-high modules or an additional subwoofer modules).

**F2)** Global Delay display. Shows the amount of delay currently applied to the overall system (subwoofer + speaker output), both in milliseconds and in meters. Users can directly write the desired amount of delay in milliseconds or meters, instead of using the Global Delay buttons.

**F3)** Dedicated Delays. Buttons in this section have exactly the same functions as the ones in the Overall delay section, but each set is dedicated exclusively to one output channel. From top to bottom: subwoofer delay, speaker output delay, and XLR DSP output delay.

**OUTPUT TAB**

Allows users to independently manage the EQ, polarity, gain and limiting threshold of the three output channels.

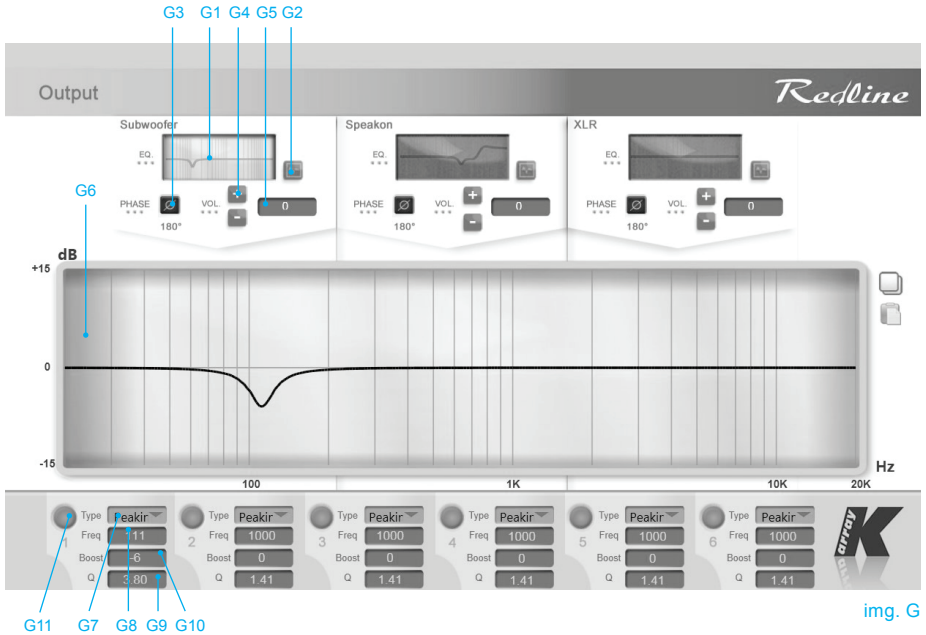

img. G

- G1) Frequency response display. Shows the frequency response curve resulting from the filters set in the Input EQ window.
- G2) Output EQ window button. Opens the Output EQ window, where users can set up to six parametric filters for each output channel.
- G3) Phase button. Inverts the channel's signal polarity (180° phase rotation).
- G4) Output Volume buttons. Adjusts the amplitude of each output channel.
- G5) Output Volume display. Shows the gain boost or reduction currently applied to each output channel. Users can directly write the desired amount of volume inside the Output Volume display, instead of using the Output Volume buttons.

*N.B.: The XLR DSP section of the Output tab does not provide the management of any limiter for this output.*

Output EQ window

- G6) Frequency response curve
- G7) Filter type menu
- G8) Filter frequency
- G9) Filter boost
- G10) Filter Q
- G11) Filter select button

## 10. SERVICE

---

To obtain service:

- 1) Contact the official K-array distributor in your country. Your local distributor will direct you to the appropriate service center.
- 2) If you are calling for service, please have the serial number(s) of the unit(s) available for reference. Ask for Customer Service, and be prepared to describe the problem clearly and completely.
- 3) If the problem cannot be resolved over the phone, you may be required to send the unit in for service. In this instance, you will be provided with an RA (Return Authorization) number which should be included on all shipping documents and correspondence regarding the repair. Shipping charges are the responsibility of the purchaser.

Any attempt to modify or replace components of the device will invalidate your warranty. Service must be performed by an authorized K-array service center.



**Cleaning:**

Use only a soft, dry cloth to clean the housing. Do not use any solvents, chemicals, or cleaning solutions containing alcohol, ammonia, or abrasives. Do not use any sprays near the product or allow liquids to spill into any openings.

## 11. SPECIFICATIONS

### KMT21

	<b>Acoustics</b>				<b>Remote control Input</b>
<b>Speakers power handling</b>	1800 w <sup>(EAS)</sup>	<b>Connectors</b>	1 male + 1 female XLR parallel		1 USB B Jack serial converter
<b>Maximum power</b>	2800 w <sup>1</sup>			<b>Power Input</b>	
<b>Impedance</b>	4Ω	<b>Connectors</b>	2 x PowerCon IN/OUT	<b>Amplifiers</b>	
<b>Frequency range</b>	30Hz - 150 Hz +/- 3dB (preset dependent)	<b>Type</b>	1 modules class D - DSP controlled		
<b>SPL 1W/1mt</b>	102 dB <sup>2</sup>	<b>Subwoofer power</b>	2400 Watt <sup>3</sup> @4Ω		
<b>Maximum SPL</b>	132 dB continuous - 138 dB peak	<b>Speaker power output</b>	2400 Watt <sup>3</sup> @4Ω		
	<b>Coverage</b>	<b>Protection</b>	Dynamic limiter, over current, over temp, short circuits	<b>AC power</b>	
	Omni	<b>Operating range</b>	Dual voltage auto-selection 85-268 V 50/60 Hz		
	Crossover	<b>Consumption</b>	670 VA		
<b>Type</b>	DSP controlled	<b>Minimum operation voltage</b>	95 Vac - 195 Vac		
<b>Frequency</b>	150 Hz maximum (preset dependent)	<b>Maximum operation voltage</b>	125 Vac - 205 Vac	<b>Physical</b>	
	<b>Transducers</b>	<b>Dimensions</b>	55.5 x 55.5 x 77.7 cm (21.85" x 21.85" x 30.59")		
	1 x 21" Neodymium speakers with 4" voice coil	<b>Weight</b>	49 Kg (108.03 lbs)		
	<b>Audio Input</b>				
<b>Analog Connectors</b>	2 male + 2 female 3-pin balanced XLR				
<b>Digital Connectors</b>	1 male + 1 female 3-pin XLR				
	<b>Audio powered Output</b>				
<b>Connector</b>	Female Speakon				
<b>Wiring</b>	Pin1+= CH1+ Pin1= CH1- Pin2+= N.C. Pin2= N.C.				

#### Notes for data

1. Maximum RMS applicable power for a musical signal, the reference signal is the one proposed by EIAJ standard.
2. Measured @4 mt then scaled @1 mt
3. Amplifier wattage rating is based on the maximum unclipped burst sine wave RMS voltage that the amplifier will produce into the nominal load impedance.

New materials and design are introduced into existing products without previous notice. Present systems may differ in some respects from those presented in this brochure.

## 12. DECLARATION OF CONFORMITY

---

Manufacturer/Importer: K-array srl unipersonale

Brand: K-ARRAY

Address: via Paolina Romagnoli - 50037 S. Piero a Sieve Firenze ITALY

Date of Issue: 10 / 01 / 2012

Model Code: KMT12 / KMT18

Declaration: Complies with essential protection requirements of Council Directive 89/336/EEC on the approximation of the Laws of the Member States relating to electromagnetic compatibility. This declaration applies to all specimens manufactured in accordance with the attached manufacturing drawings which form part of this declaration. Assessment of compliance of the product with the requirements relating to electromagnetic compatibility was based on the following standards:

Safety: EN60065 : 1998

EMC:

EN55103-1 1997 Emission (1)

EN55103-2 1997 Immunity (2)

- 1) This device may not cause harmful interference
- 2) This device must accept any interference received including interference that may cause undesired operation

Marking : 

Applying Year: 1998

Applied by: K-array srl unipersonale

Via Paolina Romagnoli

50037 S. Piero a Sieve

Firenze Italy

Tel. +39 055 8487222

Fax +39 055 8487238

Signed by: Franco Spataro - Technical Manager



The contents of this manual are furnished for informational purposes only. K-array srl Unipersonale assumes no responsibility for any errors or inaccuracies that may appear in this manual. Hp Sound Equipment s.r.l. reserves the right to make modifications without prior notice.







**K-array** s.r.l. unipersonale

Via Paolina Romagnoli - 50037  
San Piero a Sieve (Firenze) - Italy  
tel. +39 055 8487222 - fax. +39 0558487238  
e-mail: [info@k-array.com](mailto:info@k-array.com)  
[www.k-array.com](http://www.k-array.com)

